

Auftrag:	
Datum:	
Unterschrift Kunde:	

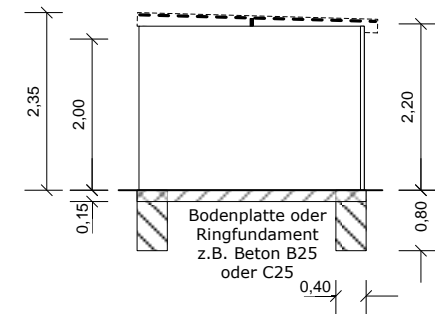
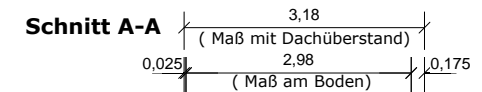
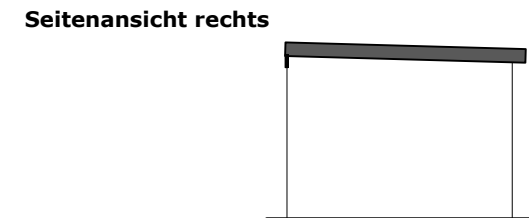
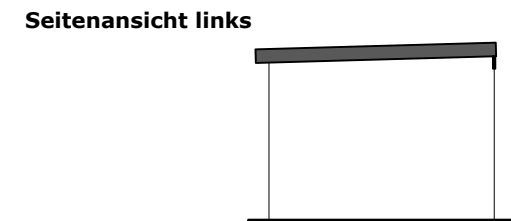
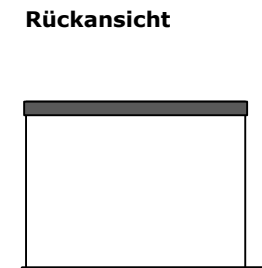
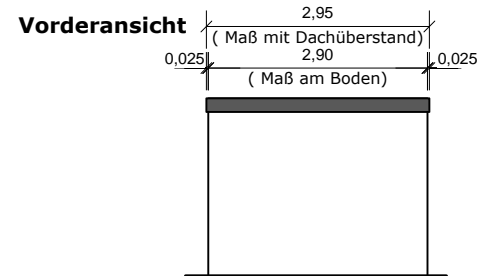
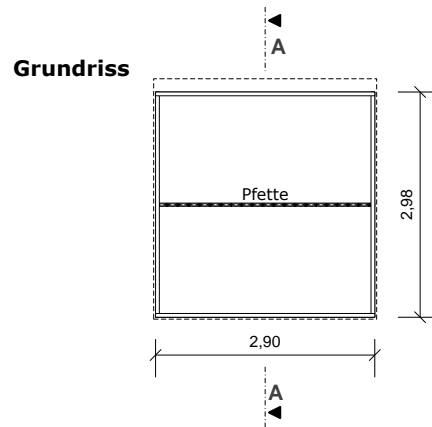

Gerätehaus Typ URBAN ONE 2900 x 2980 mm,
M 1:100, Maßangabe in Meter

Dach und Wände in Stahlelementbauweise. Wände außen verputzt.